

Net weight: 59,00 kg
 Gross weight: 94,00 kg
 Volume: 2,55 m³

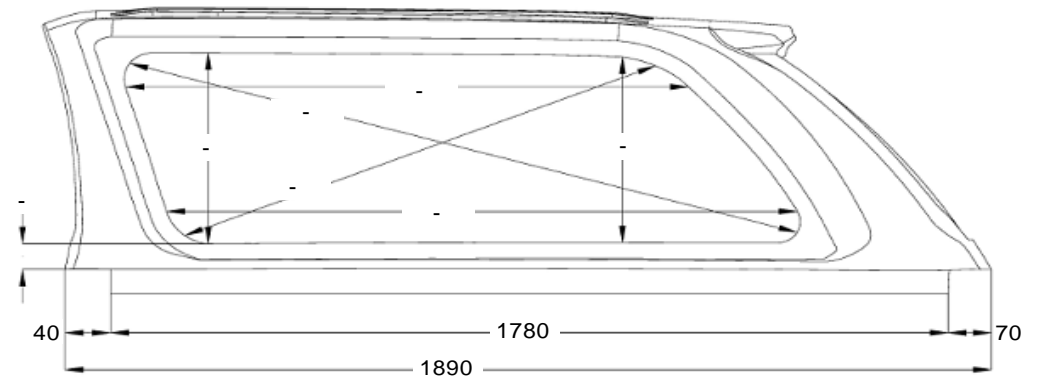
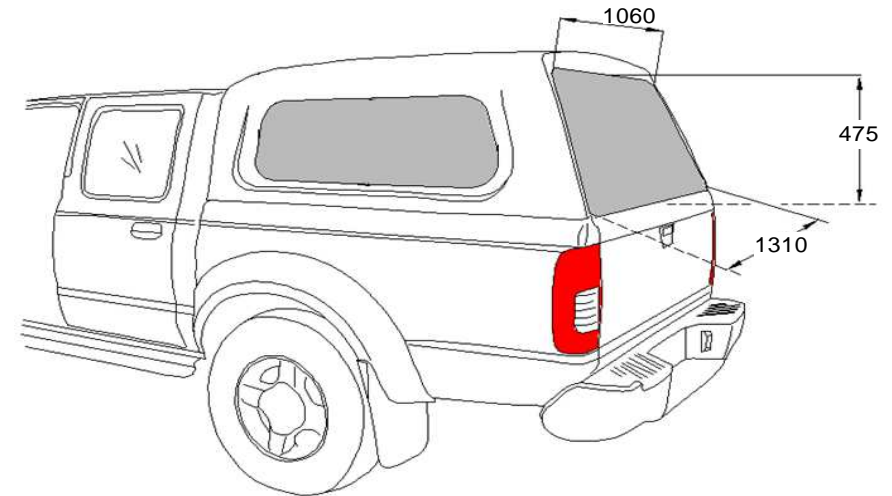

20 x 10 x 5000 GKS ECONOMY - 1,65 m
 7 X 30 X 10000 A/60/PT3 PE-L - 4 m