

Net weight: 52,00 kg
 Gross weight: 62,00 kg
 Volume: 2 m³

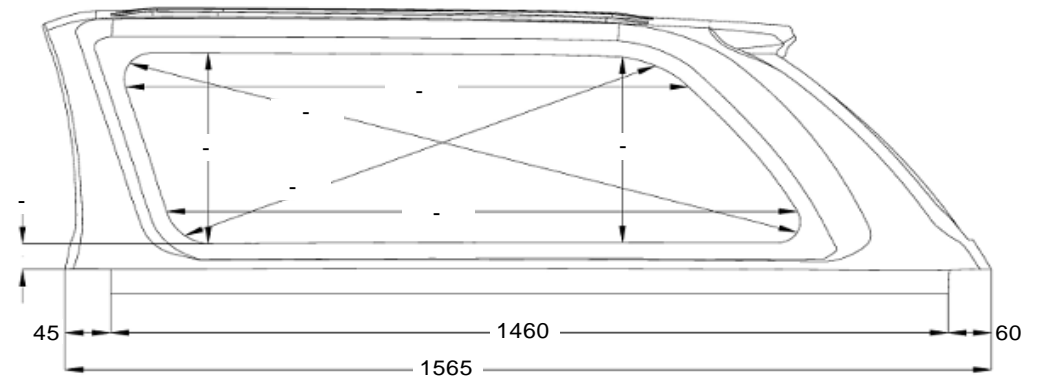
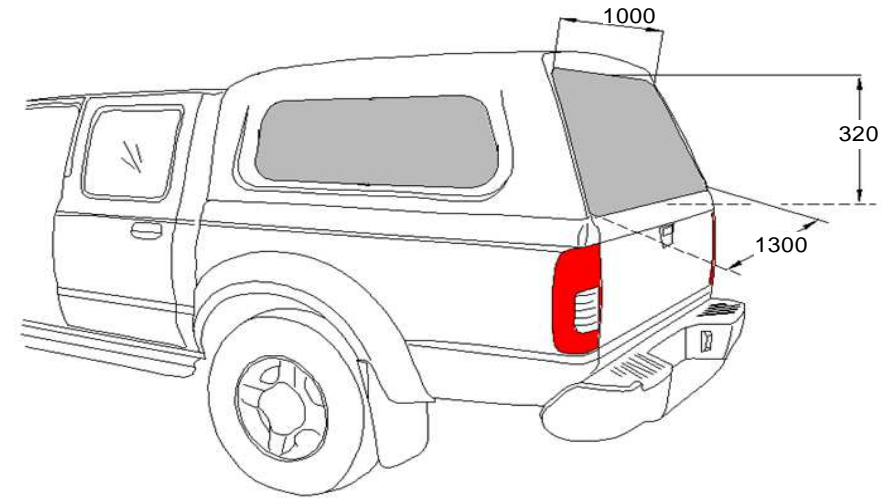

20 x 10 x 5000 GKS ECONOMY - 1,5 m
 100 - 3 m